

CLAMPBRO®



WARNING: Read these instructions before using the machine

NO GAS MIG WELDER

MODEL NO: MIG 102NG

PART NO: 6015600

OPERATION & MAINTENANCE INSTRUCTIONS



ORIGINAL INSTRUCTIONS

LS1219 - ISS 3

INTRODUCTION

Thank you for purchasing this CLARKE MIG Welder.

Before attempting to operate the machine, it is essential that you read this manual thoroughly and carefully follow all instructions given. In doing so you will ensure the safety of yourself and that of others around you, and you can also look forward to the welder giving you long and satisfactory service.

GUARANTEE

This CLARKE product is guaranteed against faulty manufacture for a period of 12 months from the date of purchase. Please keep your receipt as proof of purchase.

This guarantee is invalid if the product is found to have been abused or tampered with in any way, or not used for the purpose for which it was intended.

Faulty goods should be returned to their place of purchase, no product can be returned to us without prior permission.

This guarantee does not effect your statutory rights.

ENVIRONMENTAL RECYCLING POLICY



Through purchase of this product, the customer is taking on the obligation to deal with the WEEE in accordance with the WEEE regulations in relation to the treatment, recycling & recovery and environmentally sound disposal of the WEEE.

In effect, this means that this product must not be disposed of with general household waste. It must be disposed of according to the laws governing Waste Electrical and Electronic Equipment (WEEE) at a recognised disposal facility.

CONTENTS

INTRODUCTION	2
GUARANTEE	2
ENVIRONMENTAL RECYCLING POLICY	2
CONTENTS	3
GENERAL SAFETY INSTRUCTIONS	4
SAFETY SYMBOLS	7
THE WELDING SHIELD	7
ELECTRICAL CONNECTIONS	8
UNPACKING	9
Opening The Cover	9
OVERVIEW	10
THE CONTROL PANEL	11
PREPARATION FOR USE	12
Mounting The Welding Wire Spool	12
Setting The Drive Roller Size	12
Threading The Wire	13
MIG WELDING PRINCIPLES	15
OPERATING THE WELDER	15
Preparing The Workpiece	15
Operation	15
Thermal Overload	16
Duty Cycle	17
ACCESSORIES	17
MAINTENANCE	18
RATING PLATE	19
TROUBLESHOOTING	20
SPECIFICATIONS	22
DECLARATION OF CONFORMITY	23

GENERAL SAFETY INSTRUCTIONS



WARNING: WHEN USING ELECTRICAL TOOLS, BASIC SAFETY PRECAUTIONS SHOULD ALWAYS BE FOLLOWED TO REDUCE THE RISK OF FIRE, ELECTRIC SHOCK AND PERSONAL INJURY

WARNING: READ ALL THESE INSTRUCTIONS BEFORE ATTEMPTING TO OPERATE THIS PRODUCT AND KEEP THESE INSTRUCTIONS IN A SAFE PLACE.

ELECTRIC SHOCK

- Remove the plug from the socket and wait 5 minutes to allow the capacitors to discharge before carrying out any servicing or maintenance on this welder.
- Do not touch live electrical parts.
- Never use electrode holders or cables which are damaged.
- Keep working environment, equipment, cables and clothing free from grease, oil, moisture and dirt.
- Ensure welding machine has been correctly earthed.
- The operator must be insulated from the floor and work bench using a dry insulation mat.
- Always ensure a second person is present in case of accident.
- Never change electrodes with bare hands or damp gloves.
- Keep welding cables away from power cables.
- Regularly inspect the condition of the cables for signs of damage.
- Remove plug from the mains socket when not in use, do not leave the machine unattended.
- Ensure earth clamp is secured to bare metal adjacent to weld seam, and when not in use is

insulated for safety. - Keep all equipment well maintained.

- The operator shall prevent any gas cylinders in the vicinity of the work piece from becoming part of the welding circuit.

FUMES & GASES

- The welding process generates hazardous fumes as a by-product. Inhalation of these fumes is hazardous to health.
- Keep your head away from the weld to avoid breathing the fumes.
- If welding in confined spaces ensure adequate ventilation and use a fume extractor.
- By-products of welding can react to create a toxic/explosive environment.

FIRE OR EXPLOSION

Welding can cause fire and explosions. Precautions should be taken to prevent these hazards.

- Before starting work ensure the area is clear of flammable materials.
- Move any combustible materials to a safe distance, especially substances likely to generate a dangerous vapour.

- The welding arc can cause serious burns. Avoid contact with skin.
- Sparks and molten metal are ejected during welding. Take precautions to prevent fire.
- Sparks and molten metal can pass through gaps. Be aware that fire can start out of sight.
- Do not weld pressurised containers, or containers containing flammable vapours e.g. fuel tanks.
- Always have appropriate fire fighting equipment to hand suitable for use in electrical environments.
- Avoid carrying any fuels with you e.g. cigarette lighters or matches.

PERSONAL PROTECTION

- The body should be protected by suitable clothing.
- The use of neck protection may be necessary against reflected radiation.
- Arc machines generate a magnetic field which is detrimental to pacemakers. Consult your doctor before going near active welding equipment/operations.
- The UV and IR radiation generated by welding is highly damaging to the eye, causing burns. This can also affect the skin.
- Always use suitable welding shields equipped with appropriate protection filters.
- Where there are pedestrians and traffic ensure a protective screen is used to avoid accidental arc glare.
- Do not weld in the vicinity of children or animals and ensure no

one is looking before striking an arc.

- Wear hearing protection if required.
- Allow the weld to cool. Hot metal should never be handled without gloves.
- Take care when adjusting or maintaining the torch, that it has had time to cool sufficiently and the welder is disconnected from the mains supply.
- First aid facilities and a qualified first aid person should be available unless medical facilities are close by, for immediate treatment of flash burns of the eyes and skin burns.
- A hard hat should be worn when others are working overhead.
- Flammable hair sprays/gels should not be used by persons intending to weld or cut.

PROTECTIVE CLOTHING

- Wear gauntlet gloves designed for use in welding.
- Wear an apron, and protective shoes.
- Wear cuffless trousers (not turned up) to avoid catching sparks and slag.
- Avoid oily greasy clothing.
- Protective head and shoulder coverings should be worn when overhead welding.
- Wear helmet with safety goggles or glasses with side shields underneath, appropriate filter lenses or plates (protected by clear glass). This is a MUST for welding (and chipping) to protect the eyes

from radiant energy and spatter.
Replace cover glass when broken,
pitted, or spattered.

**NOTE: ALL protective wear inc. masks
& head shields MUST comply with PPE
Directive 89/686/EEC**

ADDITIONAL SAFETY PRECAUTIONS FOR MIG WELDING

- **ALWAYS** ensure that there is ample free air circulating around the outer casing of the machine, and that the louvres are unobstructed.
- ALWAYS inspect the hose before use to ensure it is in good condition.
- ALWAYS keep the free length of torch hose outside the work area.
- ALWAYS remove all flammable materials from the welding area.
- ALWAYS keep a fire extinguisher handy; -Dry Powder, CO² or BCF, NOT Water.
- NEVER remove any of the panels unless the machine is disconnected from the power supply, AND never use the machine with any of the panels removed.
- NEVER attempt any electrical or mechanical repair unless you are a qualified technician. If you have a problem with the machine contact your local CLARKE dealer.
- Never use or store in a wet/damp environment.
- NEVER continue to weld, if, at any time, you feel even the smallest electric shock. Stop welding IMMEDIATELY, and DO NOT attempt to use the machine until the fault is diagnosed and corrected.
- NEVER point the MIG torch at any person or animal.

- Never touch the MIG torch nozzle until the welder is switched OFF and the nozzle has been allowed to cool off.
- NEVER allow the earth cable or hose to become wrapped around the operator or any person in the vicinity.

SAFETY SYMBOLS



General Warning, indicates that failing to follow these instructions could result in injury or damage to the machine.



Recycle unwanted materials instead of disposing of them as waste. All tools, accessories and packaging should be sorted, taken to a recycling centre and disposed of in a manner which is compatible with the environment.



Read Instruction Manual before use.

THE WELDING SHIELD

1. Push the two halves of the shield together as shown, making sure the hooks and pins on the side engage correctly.
2. Place the handle into position and secure using the plastic nut provided.
3. Working from the inside of the shield, insert the clear glass panel into the recess in the shield, followed by the dark glass panel.
 - The clear glass must be inserted first.
4. Insert the two plastic screws to clamp the glass panels from the inside of the mask.

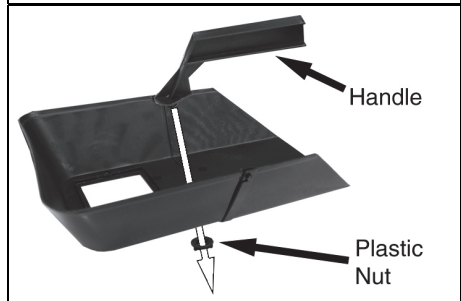
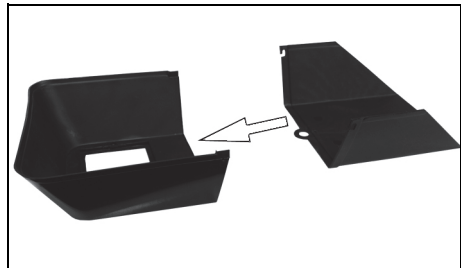

When replacing the glass panels, only use parts supplied by Clarke International. The dark panel is a certified, specific optical class, and should not be exchanged for any other type.

The clear glass panel should be replaced when it becomes badly pitted.

ELECTRICAL CONNECTIONS



WARNING! READ THESE ELECTRICAL SAFETY INSTRUCTIONS THOROUGHLY BEFORE CONNECTING THE PRODUCT TO THE MAINS SUPPLY.

Before switching the product on, make sure that the voltage of your electricity supply is the same as that indicated on the rating plate. This product is designed to operate on 230VAC 50Hz. Connecting it to any other power source may cause damage.

This product may be fitted with a non-rewireable plug. If it is necessary to change the fuse in the plug, the fuse cover must be refitted. If the fuse cover becomes lost or damaged, the plug must not be used until a suitable replacement is obtained.

If the plug has to be changed because it is not suitable for your socket, or due to damage, it should be cut off and a replacement fitted, following the wiring instructions shown below. The old plug must be disposed of safely, as insertion into a mains socket could cause an electrical hazard.



WARNING! THE WIRES IN THE POWER CABLE OF THIS PRODUCT ARE COLOURED IN ACCORDANCE WITH THE FOLLOWING CODE: BLUE = NEUTRAL BROWN = LIVE YELLOW AND GREEN = EARTH

- The wire which is coloured **Blue** must be connected to the terminal which is marked **N** or coloured **Black**.
- The wire which is coloured **Brown** must be connected to the terminal which is marked **L** or coloured **Red**.
- The wire which is coloured **Yellow and Green** must be connected to the terminal which is marked **E** or \perp or coloured **Green**.

Plug must be BS1363/A approved.

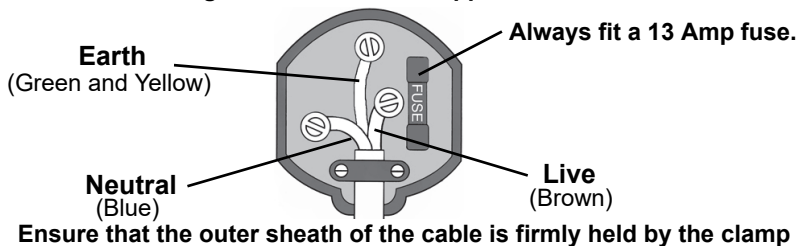

WE STRONGLY RECOMMEND THAT THIS MACHINE IS CONNECTED TO THE MAINS SUPPLY VIA A RESIDUAL CURRENT DEVICE (RCD)

If in any doubt, consult a qualified electrician. DO NOT attempt any repairs yourself.

UNPACKING

Any damage or deficiency should be reported to your CLARKE dealer immediately.

The components include the following:

- 1 x Gasless MIG Welder (torch and earth clamp attached)
- 2 x 0.9 mm Torch Tips (one installed in the torch)
- 1 x Spool Of Flux Cored Wire
- 1 x Combination Wire Brush / Hammer
- 1 x Split Welding Mask
- 1 x Instruction Manual



WARNING: NEVER OPERATE THIS MACHINE WITH THE COVER OPENED

OPENING THE COVER

IMPORTANT: *Ensure that the welder is not connected to the mains supply.*

1. Open the cover, by sliding the top back, and then lift the cover open as shown.
2. Remove any loose items that have been transported inside.

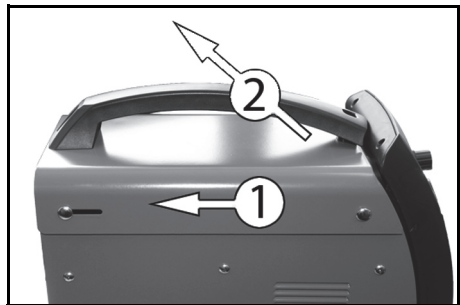

OVERVIEW



NO	DESCRIPTION	NO	DESCRIPTION
1	Handle	4	Hammer/Brush Tool
2	Control Panel	5	Torch
3	Earth Clamp	6	Torch Hose

THE CONTROL PANEL

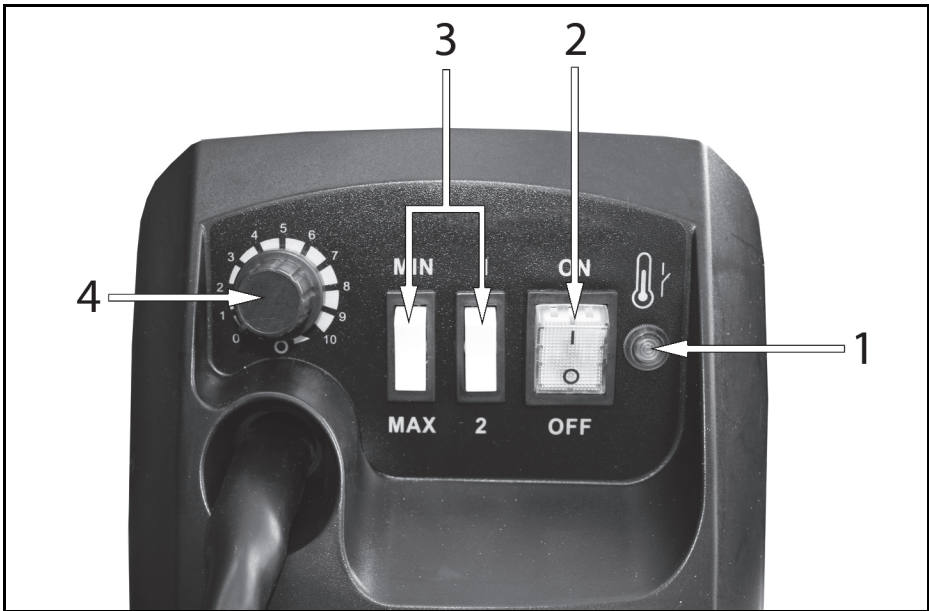

1. Thermal overload light. If the duty cycle is exceeded as a result of welding too long with a high current, the amber overload light will illuminate and the welder will turn off. When the welder has cooled down (approx. 5 to 10 minutes), the light will go out, the power will be restored and welding can recommence.

2. Power ON/OFF switch. When the power is ON, the green switch will be illuminated. When the welder is no longer required, the Power On/Off switch should be switched to the OFF position and the plug should be disconnected from the mains supply.

3. Current setting switches MIN-MAX & 1-2. Used together these two switches provide 4 increasing power levels as follows:

- MIN-1
- MIN-2
- MAX-1
- MAX-2.

4. Wire speed control knob. As a general rule, a higher current requires a higher wire speed.

PREPARATION FOR USE

MOUNTING THE WELDING WIRE SPOOL



Warning: Ensure that the welder is not connected to the mains supply.

NOTE: Spools of welding wire are available from your Clarke Dealer.

1. Open the cover, by sliding the top back, and then lift the cover open as shown on page 9.
2. Remove the locking knob and retaining disc.
3. Place the spool of welding wire (supplied) over the spindle so that it sits on the spring.
 - Do not release the tension on the wire as it will unravel causing feeding problems later.
 - The wire will feed off the spool anticlockwise from the bottom of the reel.
 - The spool must be fitted with the correct orientation otherwise it will not feed correctly.

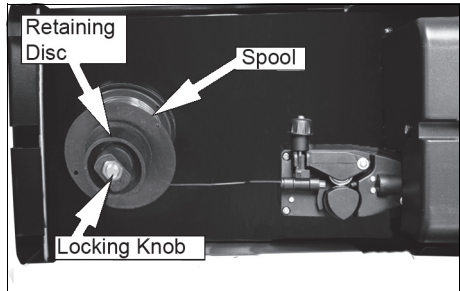

SETTING THE DRIVE ROLLER SIZE

1. Loosen the tensioning knob and pivot it towards you.
2. Lift up the arm.
3. Take hold of the triangular knob on the drive roller cover and rotate it 90° anticlockwise to release it.
4. Pull the roller retainer off the drive spindle to reveal the roller.

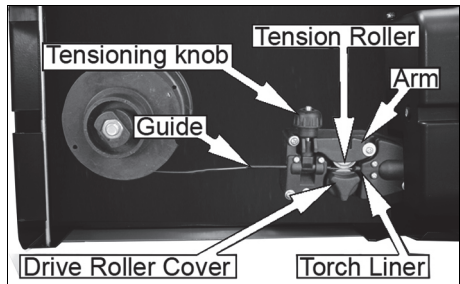

5. Pull the roller off the drive spindle.

- The groove size is stamped on the corresponding side of the roller. Select the groove size according to the size of the wire you are using and put the roller back on the spindle with your chosen side facing you.

6. Replace the drive roller cover back onto the drive spindle with the opening facing right.

7. Ensure that the flanges at the base of the drive roller cover, seat fully into the circular recess in the main moulding and then rotate the drive roller cover through 90° to lock it in place.

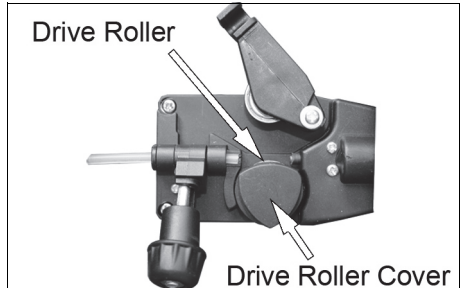

THREADING THE WIRE

IMPORTANT: Do not release the tension on the wire as it will unravel causing feeding problems later.

1. Pull out the end of the wire from the spool, taking care not to release the tension.

- We recommend you cut off and discard the first 10 cm of wire from the spool to avoid burrs and then straighten the next 15 cm of wire to help with feeding.

2. Loosen the tensioning knob and pivot it towards you.

3. Lift up the arm.

4. Pass the wire through the guide, over the drive roller and into the torch liner.

- Push about 10-15 cm into the torch liner.

5. Lower the arm and replace the tensioning knob.

- Tighten the tensioning knob sufficiently to hold firmly, but do not fully tighten.

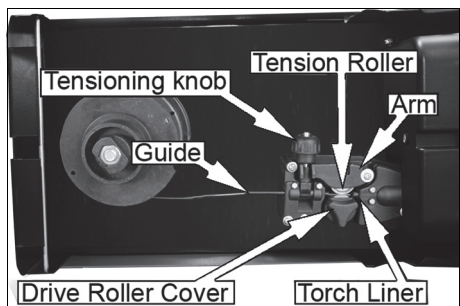

NOTE: Correct tension will allow the wire to feed into the torch liner smoothly, but will allow the drive roller to slip in the event of a blockage.

6. Lower the cover and slide it forward to close.
7. Pull off the torch shroud with a twisting movement, then unscrew the contact tip.
8. Connect the welder to the power supply and switch ON.

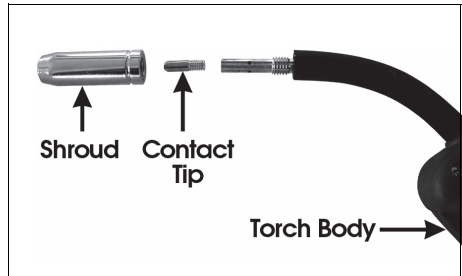

9. Set the 'WIRE FEED' rotary control on the front panel to position 7 or 8 and squeeze the trigger on the torch body.

- The wire will feed through the hose until it appears at the torch tip.
- Ensuring the hose is free from kinks during this process will assist the wire in its passage through the hose liner.

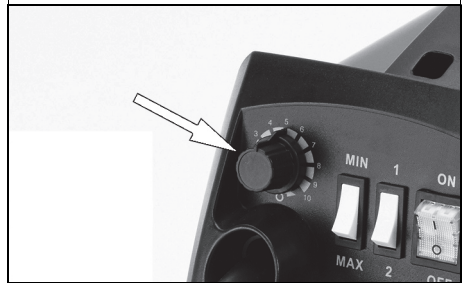

10. Release the trigger and switch off the welder and disconnect the machine from the mains supply.
11. Refit the contact tip (0.9 mm is supplied fitted) to suit your wire. then replace the shroud.
12. Trim the welding wire so that it protrudes no more than 5 mm from the end of the contact tip.

MIG WELDING PRINCIPLES

MIG (Metal Inert Gas) welding allows you to fuse together two similar metals without altering the properties of the metal.

A consumable wire electrode is continuously fed through the welding torch that is fitted with a concentric gas nozzle. The wire is connected to a high voltage supply which creates an electric arc between the electrode (the wire) and the workpiece. The arc is used to create the required heat to turn the metal into a molten state. The wire is used as both the electrode and as a filler.

When using a gasless welder the shielding gas is created from the flux within the welding wire.

When using the welder outside, you may need to erect a wind break.

OPERATING THE WELDER

PREPARING THE WORKPIECE

The area being welded should be perfectly clean. Any coating, plating or corrosion must be removed, otherwise a good weld will be impossible to achieve.

Attach the earth clamp to the workpiece as close to the point of weld as possible, without it being intrusive.

OPERATION



CAUTION: TO PREVENT THE THERMAL OVERLOAD PROTECTION FROM ACTIVATING, THE DUTY CYCLE MUST NOT BE EXCEEDED.

-
1. With the welding current set and the wire trimmed, set the wire feed control to 6.
 2. Plug the machine into the mains supply and switch ON the machine.
 3. Cover your face with a welding mask or welding helmet.
 - This is essential.
 4. Lower the torch to the workpiece with one hand and approach the work with the torch tip at an angle of about 35° and pull the torch trigger fully.
 - As the wire touches the workpiece, an arc will be struck.

5. In order to produce a satisfactory weld, the controls may be fine tuned as required. This will come with practice.

NOTE: MIG welding is an acquired skill, it is strongly advised that, if you are not fully familiar with this type of welding, you practice on a piece of material with the same characteristics as your workpiece, until you are satisfied with the result, and you have fine tuned your welder to produce a satisfactory weld.

NOTE: One of the problems experienced with novice welders, is the welding wire sticking to the contact tip. This is as a result of the wire feed speed being too slow. It is always better therefore to start with too high a speed, and back off slightly, to avoid the possibility of the wire welding itself to the tip. This is the reason position 6 is recommended for start up.

NOTE: The Wire Feed control is for fine tuning the wire speed. The speed of wire delivery will increase automatically as the current is increased. Therefore, once the ideal speed is achieved by fine tuning, it should not be necessary to adjust this control when the welding current is changed.

NOTE: Listen to the sound made. An irregular crackling sound denotes too high a wire speed. Decrease the speed until a regular, strong buzzing sound is heard.

THERMAL OVERLOAD

The 'Thermal Overload' shuts off the welder when it becomes too hot, due to the duty cycle being exceeded. This is to prevent any damage to the machine.

When this occurs, the warning lamp shown will glow (amber). Allow the welder to cool, until the amber light extinguishes before resuming work.









DUTY CYCLE

These welders are covered by regulations EN 60974-1 and EN 60974-10, where the duty cycle is expressed as a percentage of time the machine may be used in a given period for a specified welding current.

Using the example shown, which is an illustration of the data plate;-

e.g. when welding at 35 amps the machine may be used for 6 minutes (60%) in any 10 minute period.

		<small>Imported by</small> 	
Model No: MIG102NG Part No: 6015600		Serial No: EN 60974-1 Batch No:	
		35A / 15.7V / 90A / 18.5	
		X	10% / 60%
		U ₀ = 20V-30V	I ₂ 90A / 35A U ₂ 18.5V / 15.7V
		1 ~ 50Hz	U ₁ = 230V I _{1MA} = 16A I ₁ = 5.8A
IP21S			

ACCESSORIES

The following are some of the accessories available from your CLARKE dealer. Please quote the part numbers shown below:

PART	DESCRIPTION	PART NUMBER
Welding Wire Spools	Mini - 0.9mm flux-cored	8132110
Arc Activated Head-shields	CWH6	6000671
	CWH7 (Flame)	6000672

MAINTENANCE



WARNING: ELECTRICITY CAN KILL - NEVER TOUCH LIVE ELECTRICAL COMPONENTS.

WARNING: DISCONNECT THE POWER SUPPLY BEFORE ALL INSPECTIONS AND MAINTENANCE OPERATIONS. BEWARE HOT SURFACES.

WARNING: ALWAYS LET THE WELDER COOL DOWN BEFORE ACCESSING INTERNAL COMPONENTS.

Frequency of maintenance operations depends on the operating conditions, how intensively the welder is used and how clean or dirty the welding site is (aggressive environments etc).

Always inspect the earth cable and torch hose before use, to ensure they are in perfect condition and that the earth clamp is clean and secured correctly to the cable.

Check the hose for security and damage.

As a general rule the power supply should be inspected at least annually. Consult your CLARKE dealer for advice if necessary.

Wire feed unit:

The feed roller wire guide plays an important part in obtaining consistent results. Clean the rollers weekly, especially the feed roller groove, removing all dust deposits.

Torch:

Protect the torch hose assembly from mechanical wear. Clean the liner from the machine forwards by using compressed air. If the liner is blocked it must be replaced.

Contact tip:

The contact tip is a consumable item and must be replaced when the bore becomes enlarged or oval. The contact tip **MUST** be kept free from spatter to ensure an unimpeded flow of gas.

To keep the contact tip free from spatter, we recommend the use of anti-spatter spray (Part number: 6000715) available from your CLARKE dealer.

Torch shroud:

The torch shroud must also be kept clean and free from spatter. Build-up of spatter inside the gas cup can cause a short circuit at the contact tip which will result in expensive machine repairs.

RATING PLATE

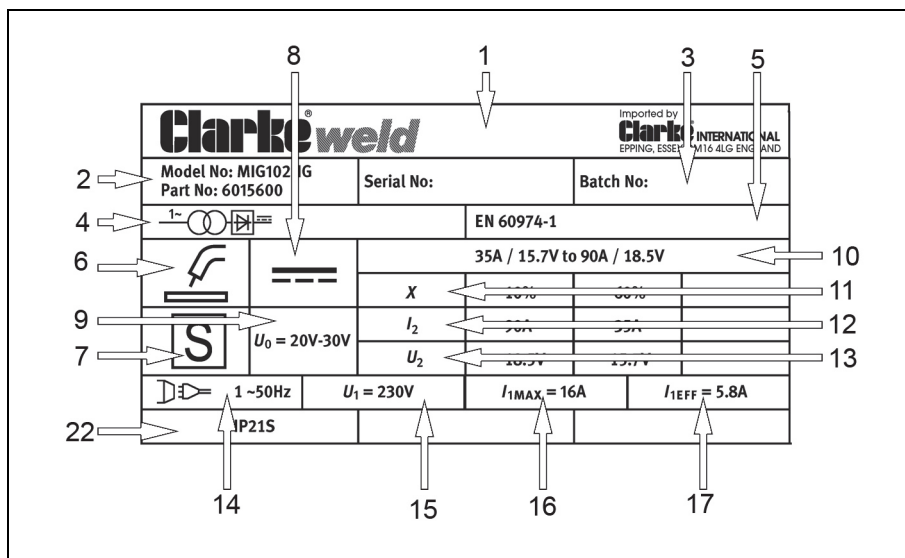

1	Name and address of manufacturer	13	Load Voltage symbol
2	Model number, part number	14	Energy Input symbol
3	Batch number	15	Rated supply voltage
4	Single phase transformer-rectifier	16	Rated maximum supply current
5	British Standards applied	17	Maximum effective supply current
6	Welding process	18	N/A
7	This symbol indicates that the unit is suitable for carrying out welding operations in an environment which has an increased risk of electric shock.	19	N/A
8	Welding Current symbol - direct current.	20	N/A
9	Rated no-load voltage	21	N/A
10	Min+max welding current and corresponding load voltages	22	Degree of protection
11	Duty Cycle symbol	23	N/A
12	Rated Welding Current symbol	24	N/A

TROUBLESHOOTING

Your CLARKE MIG Welder has been designed to give long and trouble free service. If, however, having followed the instructions in this booklet carefully, you still encounter problems, the following points should help identify and resolve them.

PROBLEM	CAUSE	SOLUTION
No response from welder	Check fuses and mains lead	Replace fuses as necessary. If problem persists return welder to your local dealer
		Check fuse size
Welder does not feed wire	Feed motor has malfunctioned.	Return welder to your local dealer
Feed motor running but no wire being fed from welder tip	Insufficient Feed Roller pressure	Increase roller pressure
	Burr on end of wire	Re-cut wire square with no burr
	Liner blocked or damaged	Clean with compressed air or replace liner.
	Inferior wire	Use only good "clean" wire
	Roller worn out	Replace roller
Wire welds itself to tip	Wire feed speed too low	Unscrew tip, cut wire and fit new tip Increase wire speed before operating again
	Wrong size tip	Fit correct size tip
Wire feeds into 'birds nest' tangle	Wire welded to tip	As above plus reduce feed roller pressure
	Wire liner damaged preventing smooth operation	Renew wire liner
Loose coils of wire tangle around wire drum inside machine	Locking knob too slack	Tighten Locking Knob slightly. Do not over-tighten

PROBLEM	CAUSE	SOLUTION
Erratic wire feed	Locking Knob too tight	Loosen Locking Knob slightly
	Feed roller worn	Check and replace if necessary
	Insufficient pressure on feed roller	Increase pressure on feed roller Caution: Do not over-tighten
	Wire dirty, rusty, damp or bent	Re-cut wire and ensure it is clean
	Liner partially blocked	Clean with compressed air
Poor quality welds	Poor earth contact	Check earth clamp/workpiece connection
	Rusty, painted, damp, oil or greasy workpiece	Ensure workpiece is clean and dry
	Rusty/dirty wire	Ensure wire is clean and dry
Welder cuts out whilst in use	Duty cycle exceeded (auto cut-out operates)	Allow welder to cool 15-30 mins before continuing Note: If duty cycle is continually exceeded, damage to the welder may result, and welder output is probably too small for application

If you have any problems which cannot be resolved by reference to the above, or if you require spare parts for your welder please contact your local Clarke dealer.

SPECIFICATIONS

Model	MIG102NG
Part No	6015600
Weight	16.65 kg
Dimensions (l x w x h) mm	420 X 192 X 362
Power Supply	230 V @ 50Hz
IP Rating	IP21S
Output Min/Max Amps	35 / 90 A
Open Circuit Voltage	20-30 V DC
Rated Max Input Current	16 A

The details and specifications contained herein, are correct at the time of going to print. However, CLARKE International reserve the right to change specifications at any time without prior notice.

DUTY CYCLE

The duty cycle determines the machine 'down time'. i.e 10% means 1 minutes operation followed by 9 minutes of rest. **The duty cycle must not be exceeded to prevent the thermal cutout protection from activating.**

Duty Cycle (%)	10	60
Rated Welding Current (A)	90	35
Conventional Load Voltage (V)	18.5	15.7

Do not exceed the stated duty cycle for this machine. Failure to heed this warning may invalidate your warranty.

DECLARATION OF CONFORMITY



Clarke[®]
INTERNATIONAL

Hemnall Street, Epping, Essex CM16 4LG

DECLARATION OF CONFORMITY

This is an important document and should be retained.

We hereby declare that this product(s) complies with the following directive(s):

2014/30/EU *Electromagnetic Compatibility Directive.*
2014/35/EU *Low Voltage Equipment Directive.*
2011/65/EU *Restriction of Hazardous substances.*

The following standards have been applied to the product(s):

EN 60974-1:2012, EN 60974-10:2014+A1:2015.

The technical documentation required to demonstrate that the product(s) meet(s) the requirement(s) of the aforementioned directive(s) has been compiled and is available for inspection by the relevant enforcement authorities.

The CE mark was first applied in: 2008

Product Description: Mig Welding Machine
Model number(s): MIG102NG
Serial / batch Number: N/A
Date of Issue: 14/05/2019

Signed:

J.A. Clarke
Director

A SELECTION FROM THE VAST RANGE OF

Clarke®

QUALITY PRODUCTS

AIR COMPRESSORS

From DIY to industrial, Plus air tools, spray guns and accessories.

GENERATORS

Prime duty or emergency standby for business, home and leisure.

POWER WASHERS

Hot and cold, electric and engine driven - we have what you need

WELDERS

Mig, Arc, Tig and Spot. From DIY to auto/industrial.

METALWORKING

Drills, grinders and saws for DIY and professional use.

WOODWORKING

Saws, sanders, lathes, mortisers and dust extraction.

HYDRAULICS

Cranes, body repair kits, transmission jacks for all types of workshop use.

WATER PUMPS

Submersible, electric and engine driven for DIY, agriculture and industry.

POWERTOOLS

Angle grinders, cordless drill sets, saws and sanders.

STARTERS/CHARGERS

All sizes for car and commercial use.

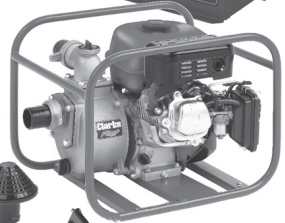
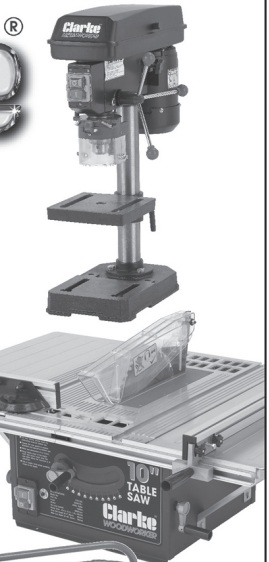

PARTS & SERVICE: 0208 988 7400

E-mail: Parts@clarkeinternational.com or Service@clarkeinternational.com

SALES: UK 01992 565333 or Export 00 44 (0)1992 565335

Clarke® INTERNATIONAL Hemnall Street, Epping, Essex CM16 4LG
www.clarkeinternational.com